

Aluminium support system for rainscreen cladding

NV5 NVELOPE SYSTEM TRESPA TS300 SYSTEM

LEGEND:

- A - cladding
- B - joint profile
- C - clamp
- D - corner-profile
- F - window profile
- 1 - Wall
- 2 - NVELOPE - support bracket
- 3 - Stainless steel fixing
- 4 - Vertical timber
- 5 - Self drilling stainless steel screw SR2 4.2 x 16
- 6 - Vertical Timber Batten
- 7 - Thermal insulation
- 8 - Ventilation
- 9 - Timber carrier
- 10 - NVELOPE Thermal isolator
- 11 - Timber fixing screw

CONTENTS:

- NV5-01 Tolerances for Bracket Adjustment
- NV5-02 Cladding View Locations
- NV5-03 TS300 Profile Detail
- NV5-04 Trespa Machining Details
- NV5-05A Horizontal Section Board Joint
- NV5-05B Horizontal Section Board Joint
- NV5-06 Vertical Section Movement Joint
- NV5-07A Vertical Joint
- NV5-07B Vertical Joint
- NV5-08 Vertical Section at Base
- NV5-09 Vertical Section Parapit
- NV5-10 Vertical Section Window sill
- NV5-11 Horizontal Section Window Reveal with Trespa
- NV5-12 Horizontal Section Window Reveal with trim
- NV5-13A Vertical Section Window head Detail (version A)
- NV5-13B Vertical Section Window head Detail (version B)
- NV5-13C Vertical Section Window head Detail (version C)
- NV5-14 Horizontal Section Rail Positions
- NV5-15 Horizontal Section Internal Corner
- NV5-16 Horizontal Section External Corner

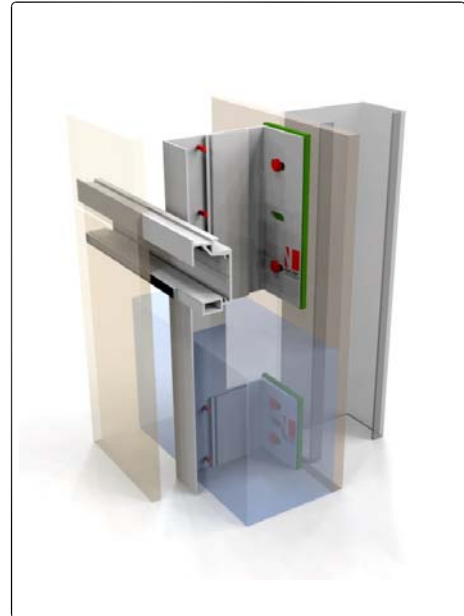

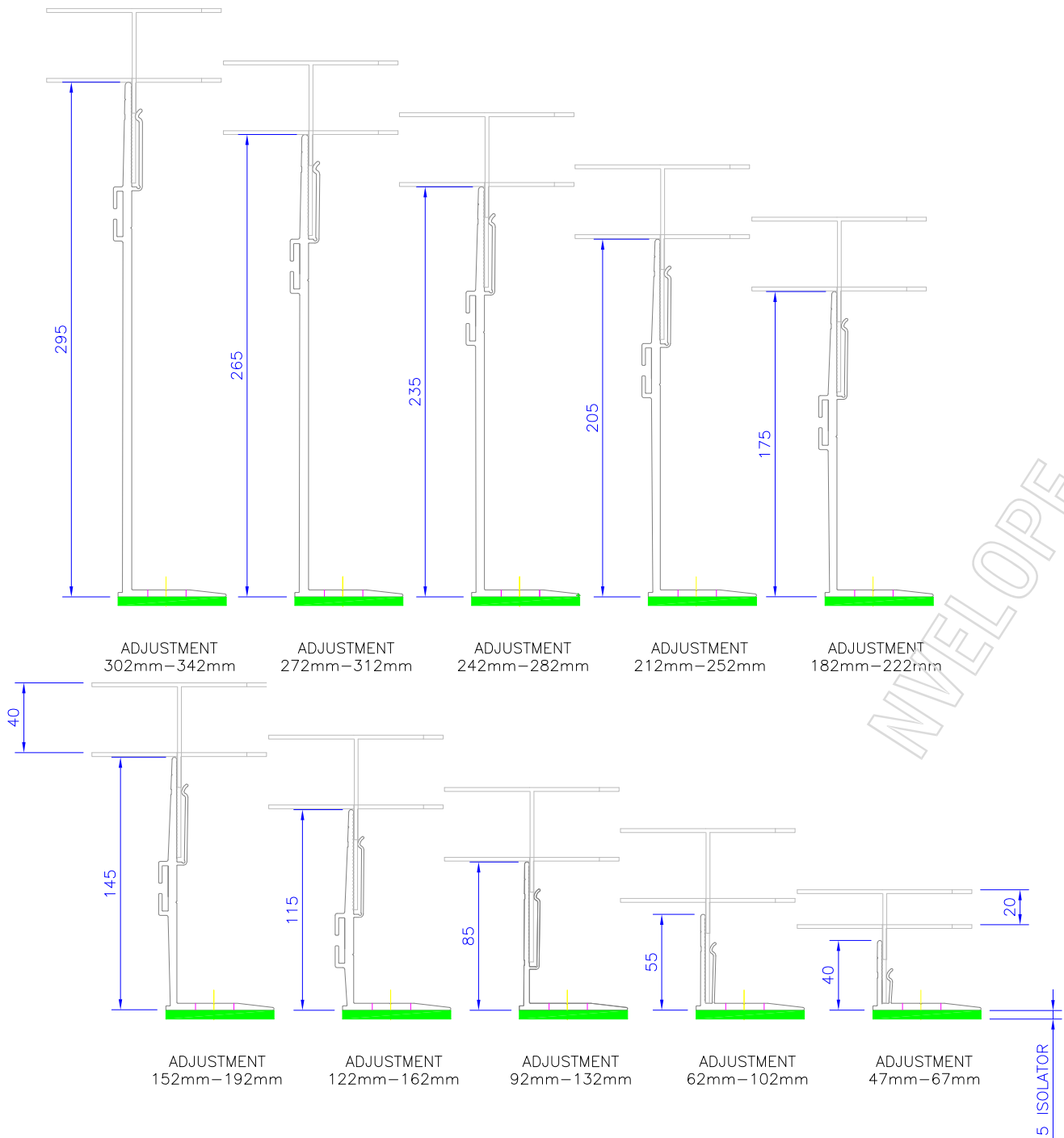

BRACKETS	Adjustment range for each bracket (mm)	
Nvelope 40	from 47	to 67
Nvelope 60	from 62	to 102
Nvelope 90	from 92	to 132
Nvelope 120	from 122	to 162
Nvelope 150	from 152	to 192
Nvelope 180	from 182	to 222
Nvelope 210	from 212	to 252
Nvelope 240	from 242	to 282
Nvelope 270	from 272	to 312
Nvelope 300	from 302	to 342

HORIZONTAL SECTIONS
TOLERANCES FOR ADJUSTMENT

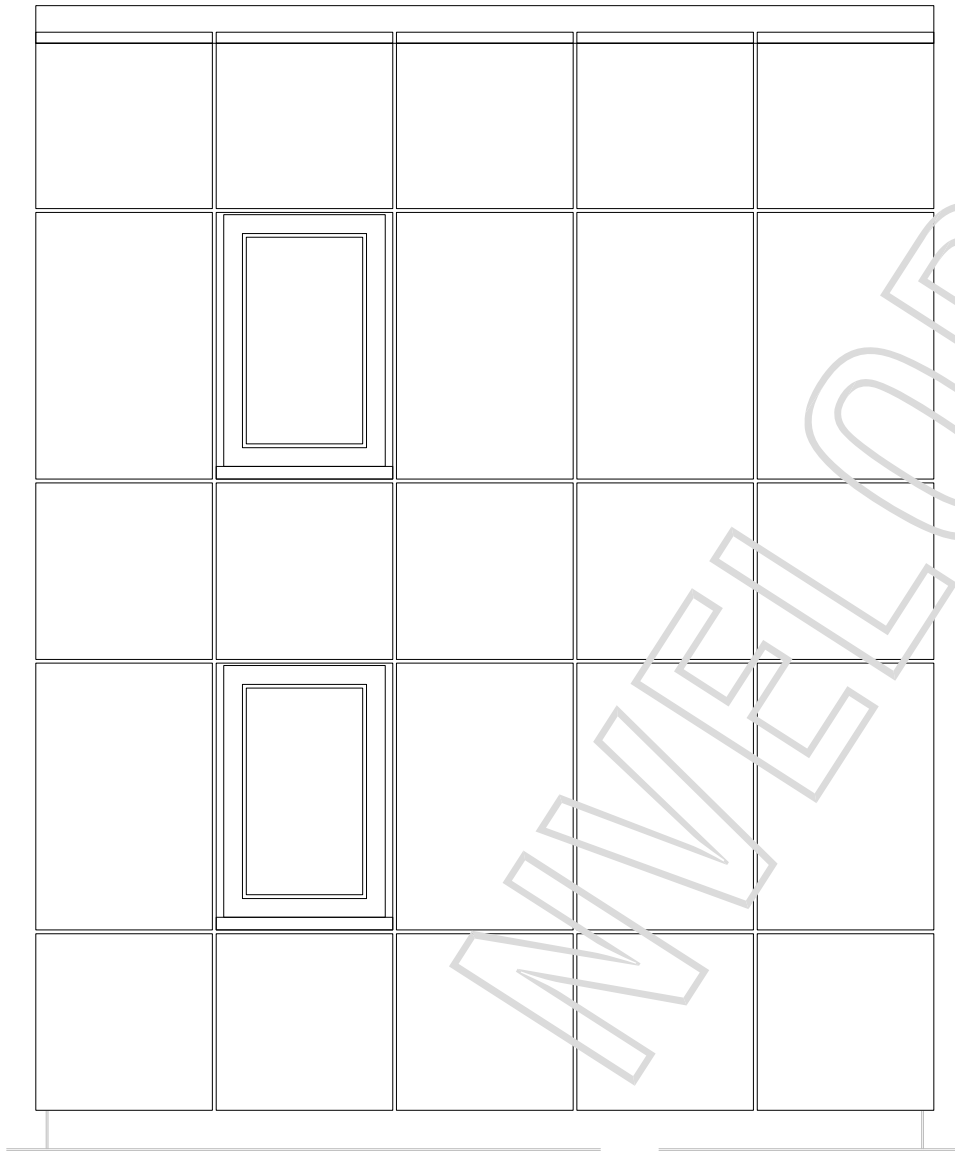

View of Cladding

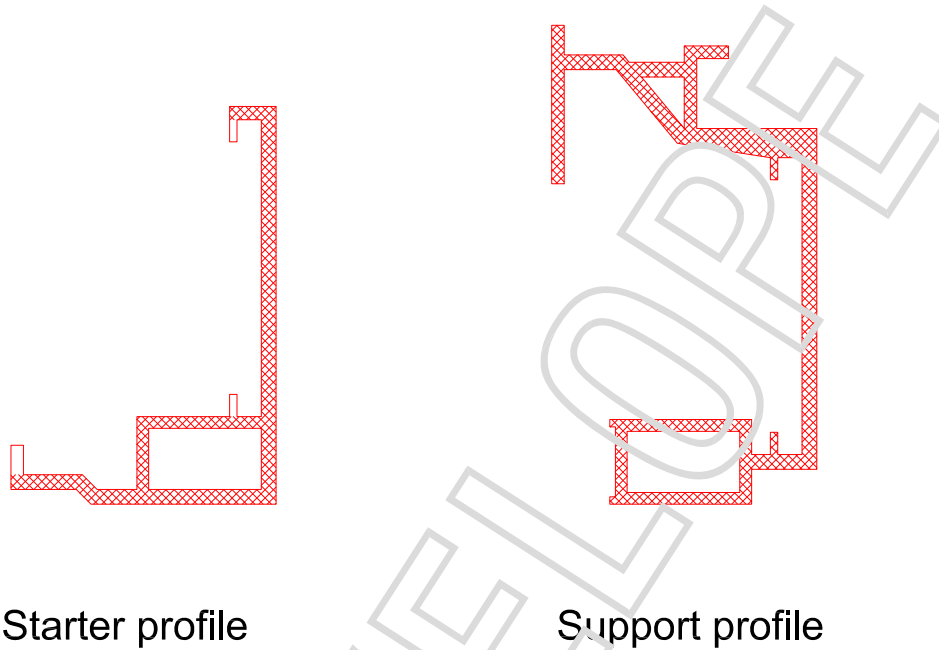

Cladding thickness	wind normal area	wind corner area
8 mm	1,75 m	1,23 m
10 mm	1,56 m	1,10 m
13 mm	1,15 m	0,98 m

Windloads: Dynamic pressure $q = 0,80 \text{ kN} / \text{m}^2$ (in acc. to DIN 0-20 m)
 Vertical distances of start- and support profiles are equal !

Thickness	Panel height	Panel length
8 mm	600 mm	3650 mm
10 mm	750 mm	3650 mm
13 mm	900 mm	3650 mm

Panel forms

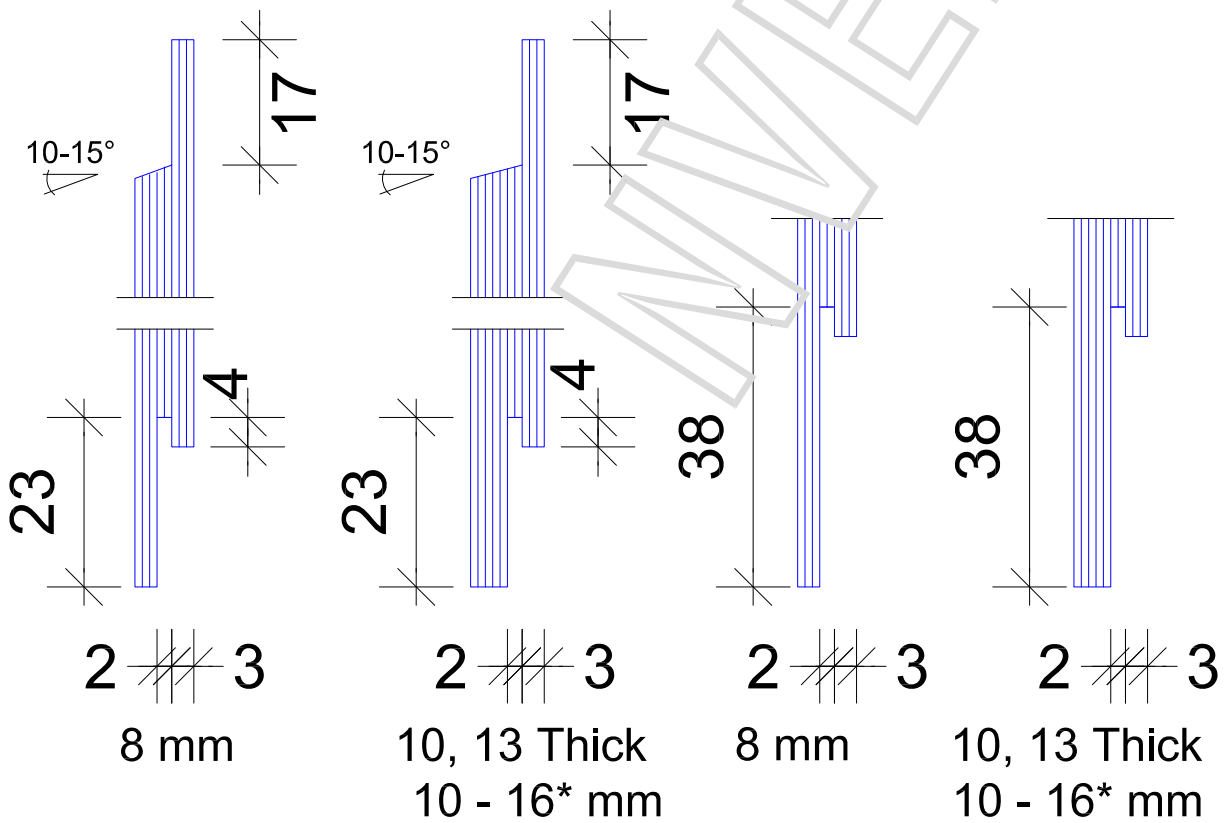

* Originals panels

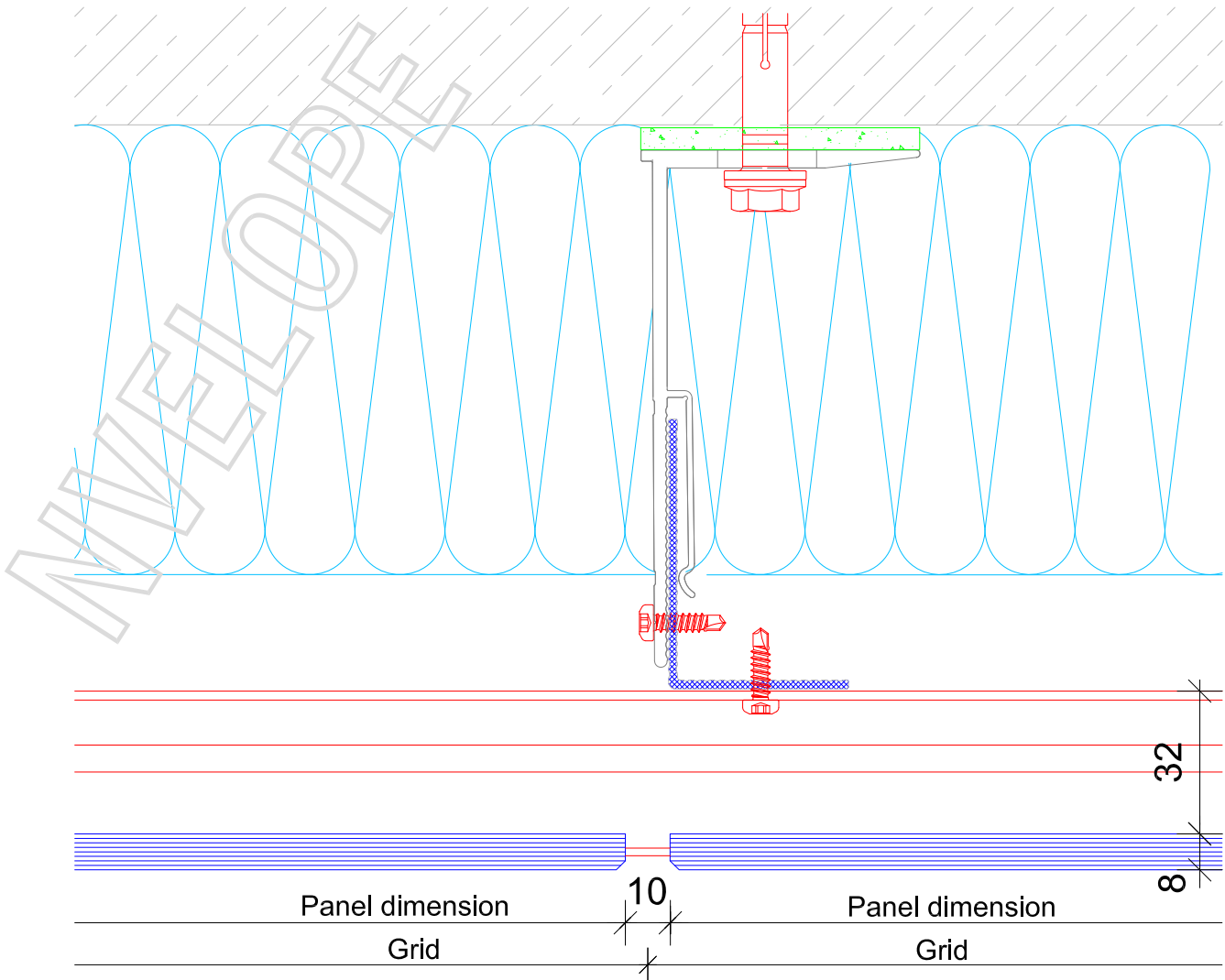

Variants Vertical joint

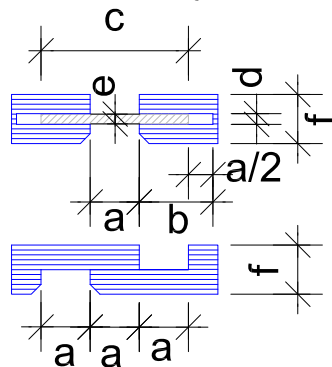

- a. 10 mm
- b. 15 mm
- c. 30 mm
- d. 2,2 mm Al / 3,2 mm Trespa
- e. 2,0 mm Al / 3,0 mm Trespa
- f. 8 mm or 10 mm

Horizontal section - NVELOPE 120

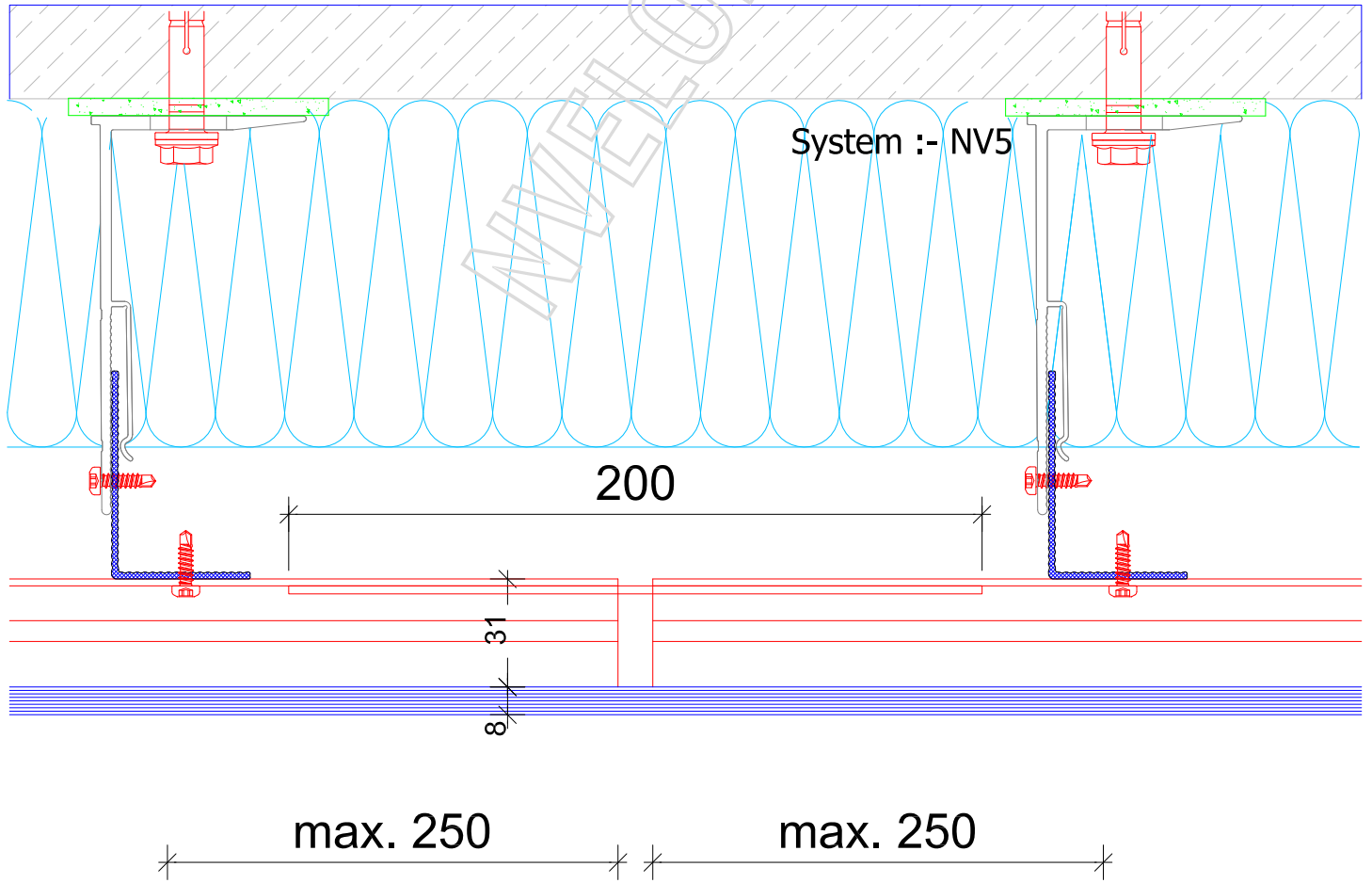

Horizontal section - NVELOPE 120 - joint of profile

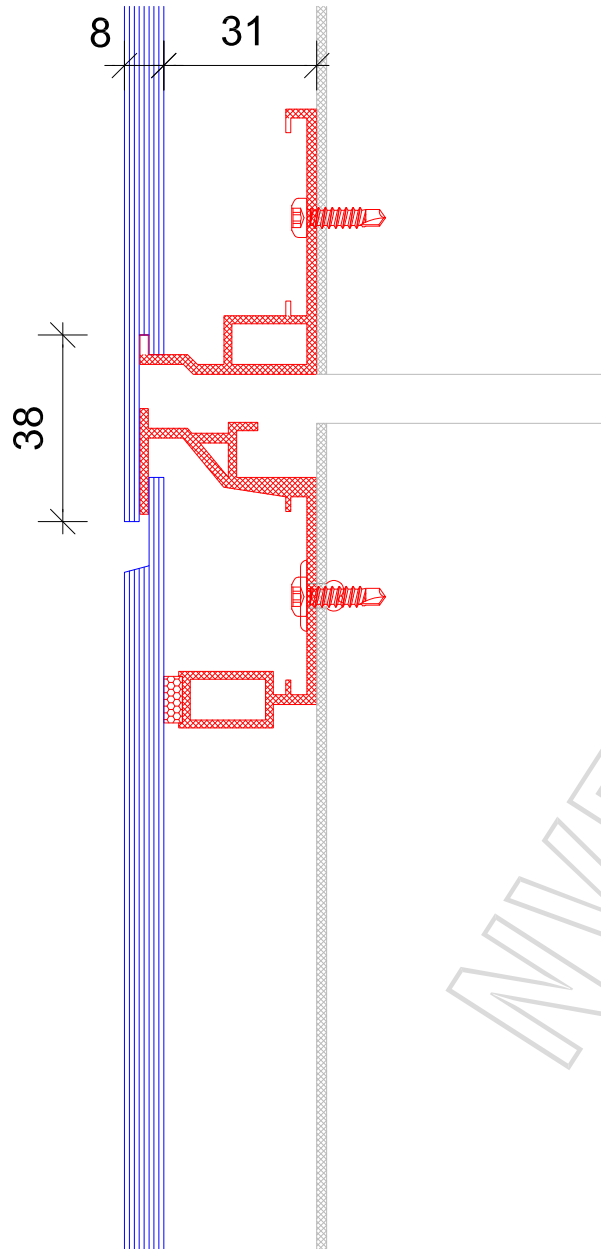

Vertical section - at joint of profile/ board

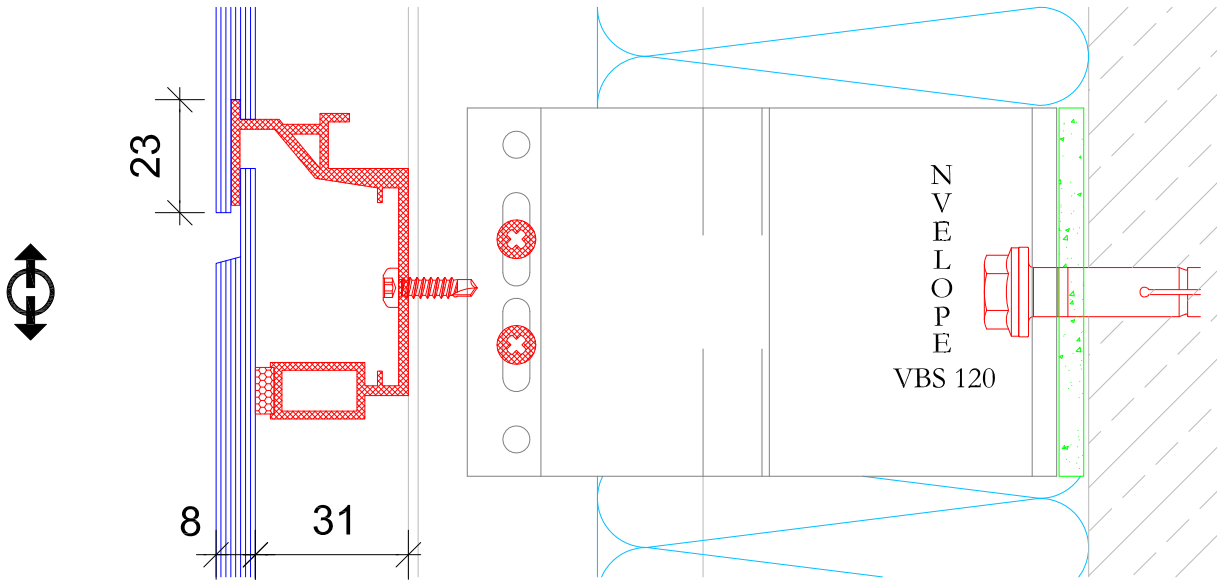

Vertical section-flexible point

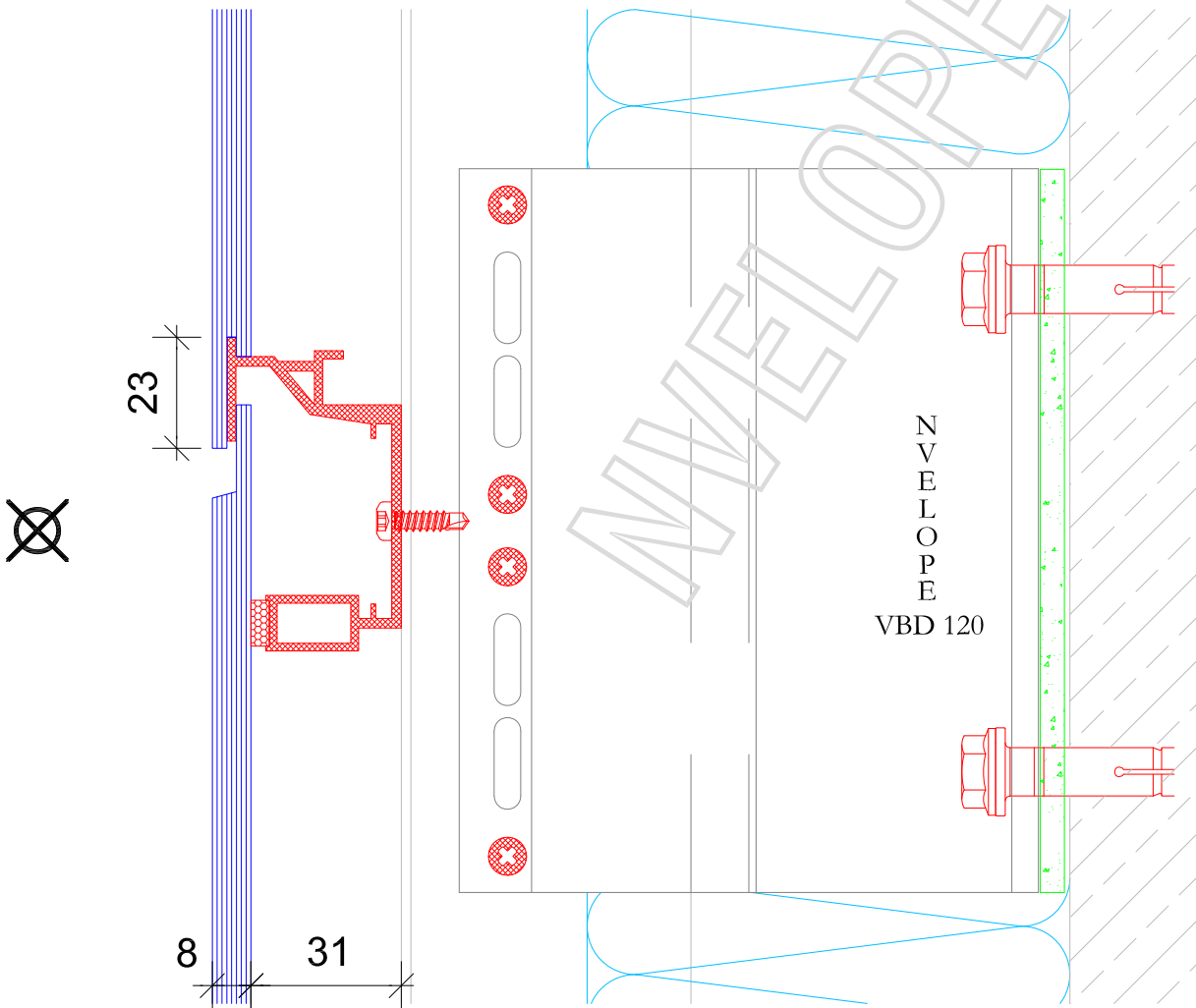

Vertical section-fixed point

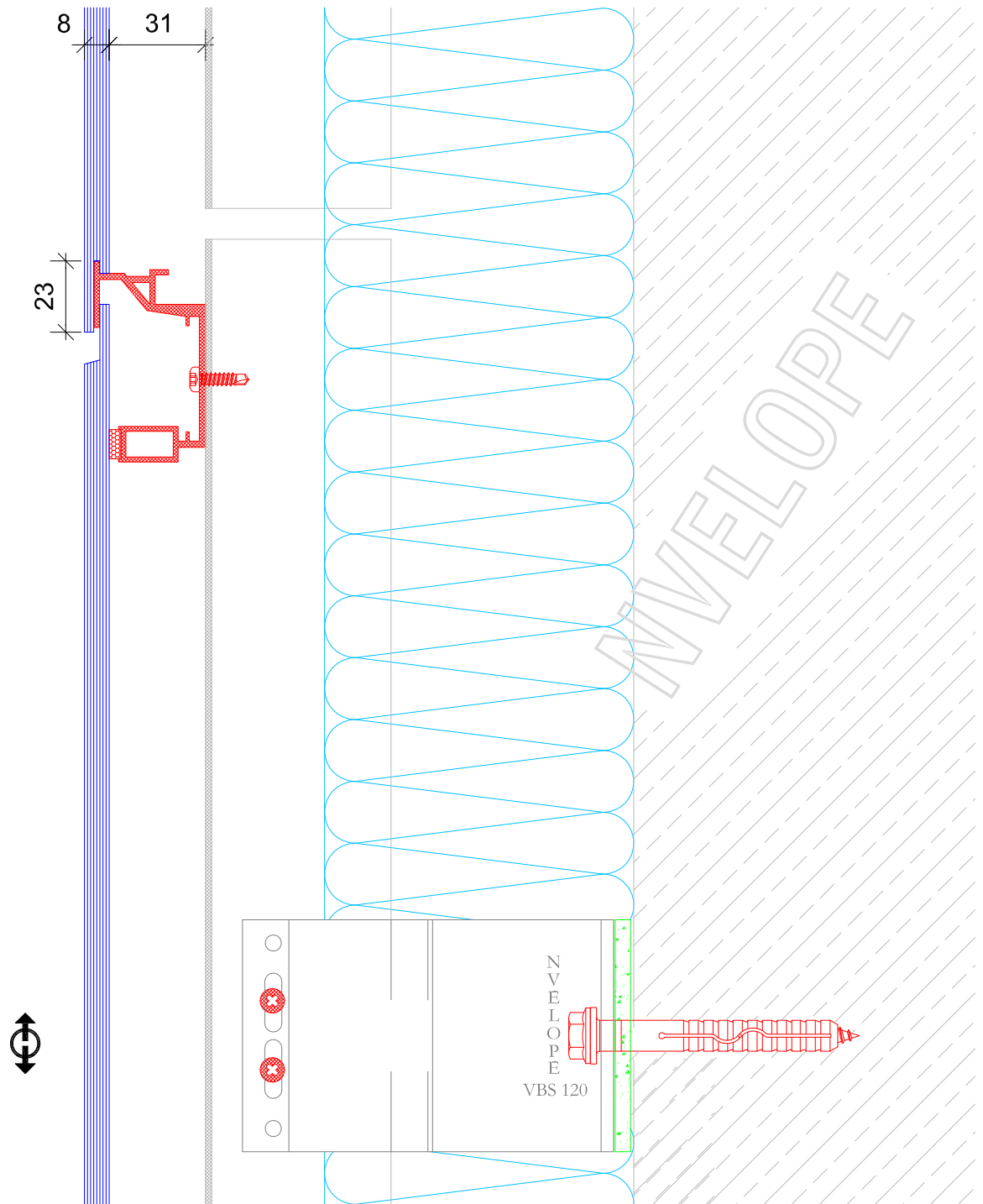

Vertical section - NVELOPE 120 - joint of profile

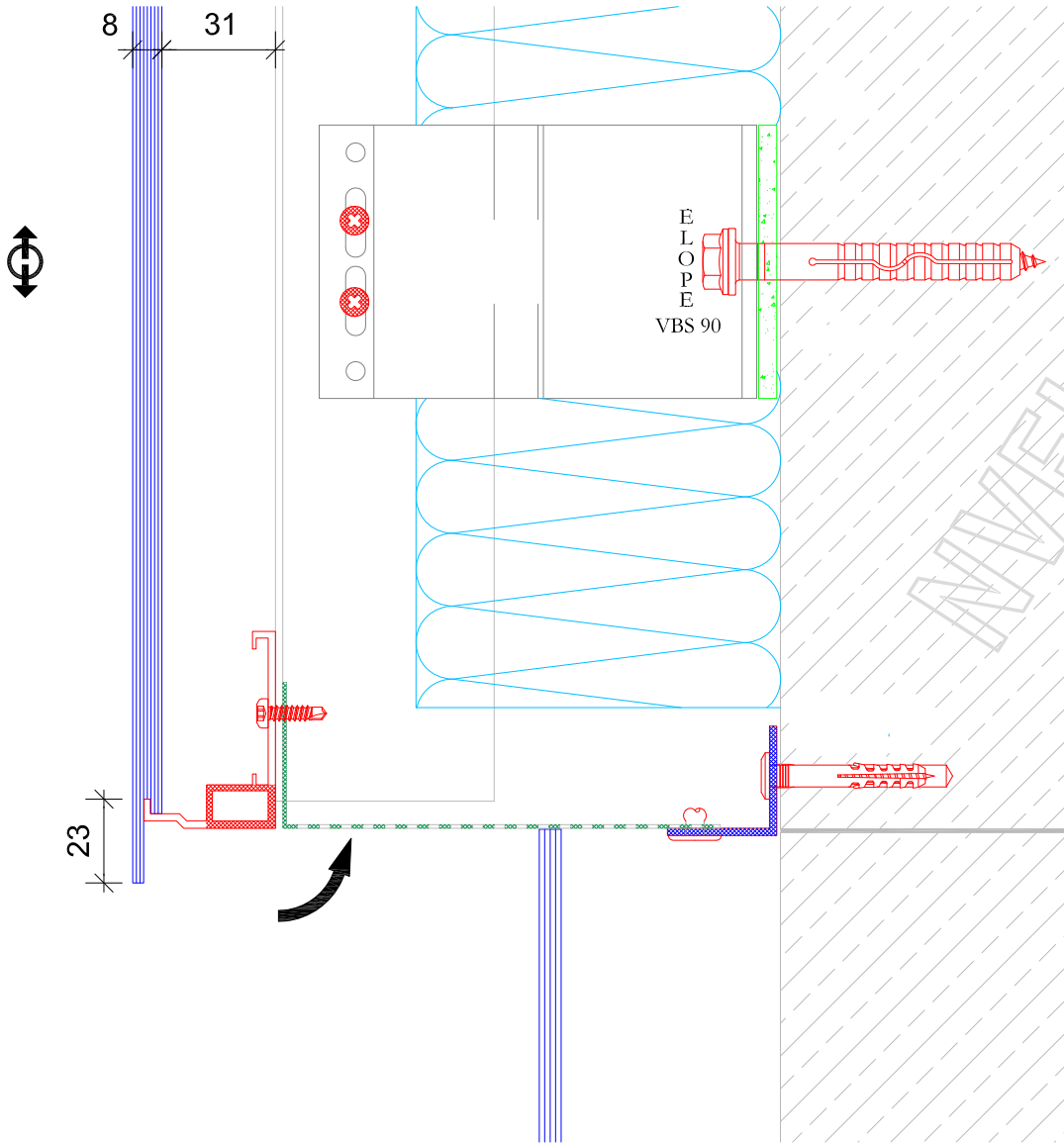

Vertical section - bottom detail

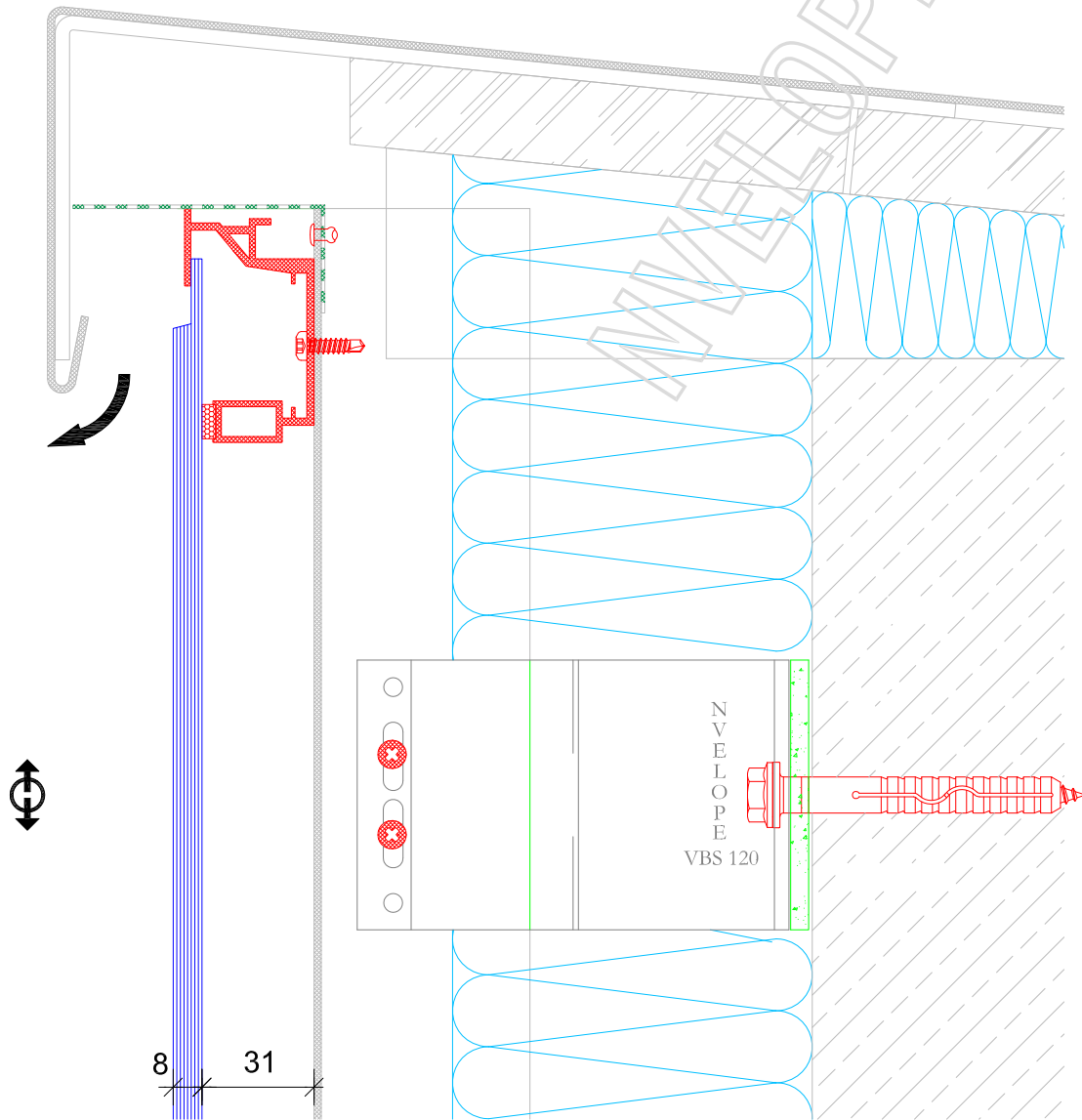

Vertical section

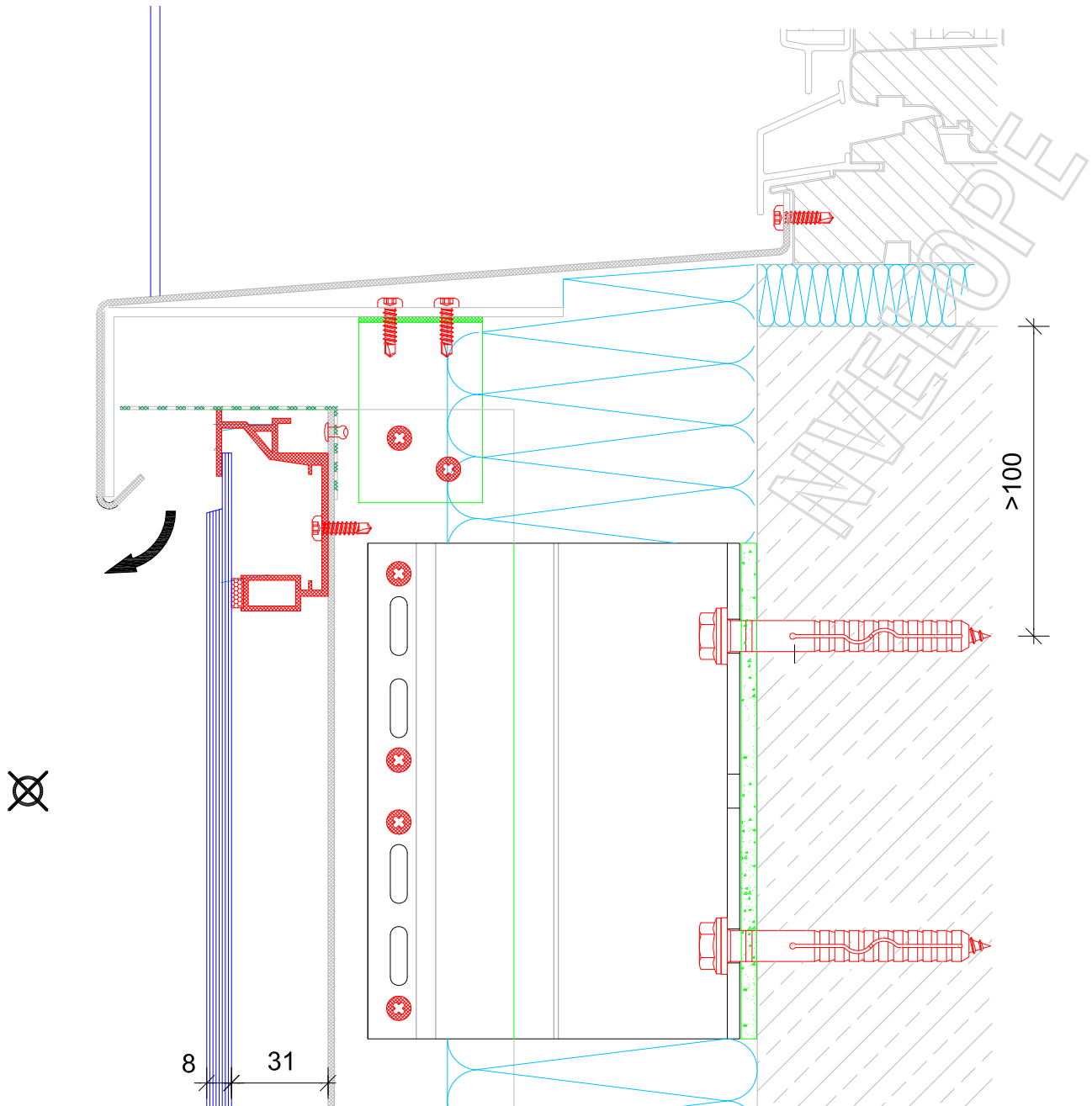

Vertical section - window sill detail

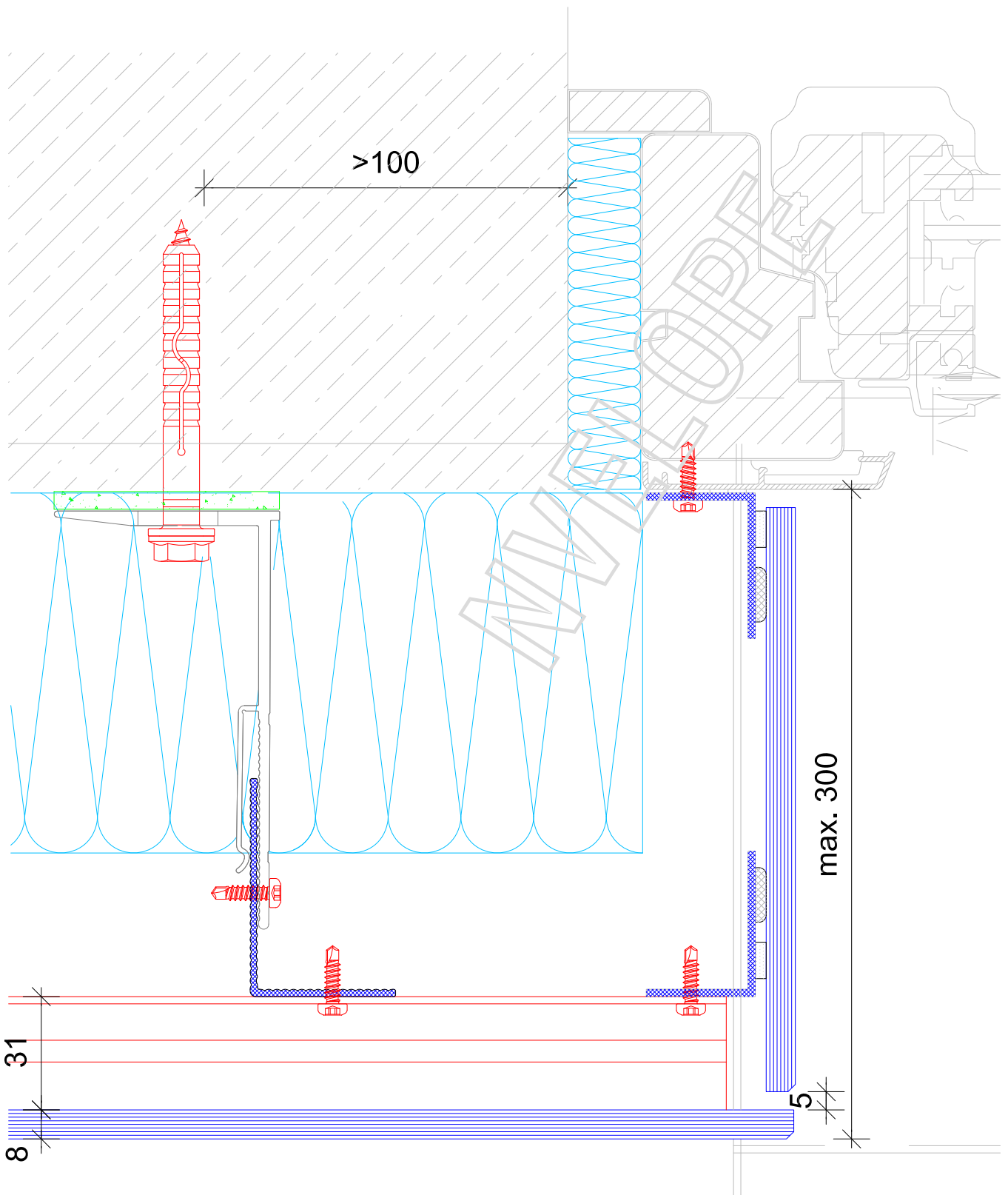

Horizontal section - window - reveal

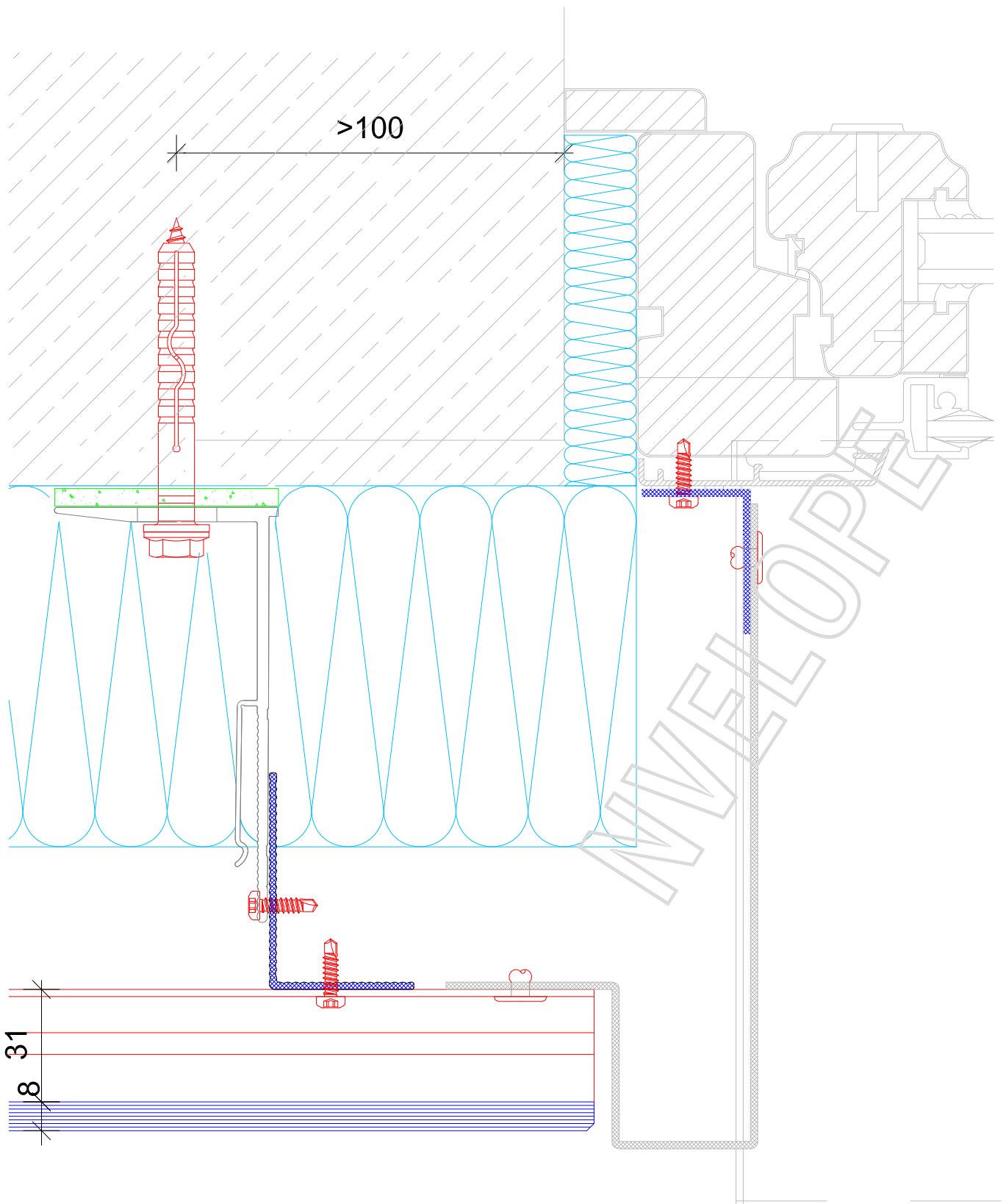

Horizontal section - window - reveal

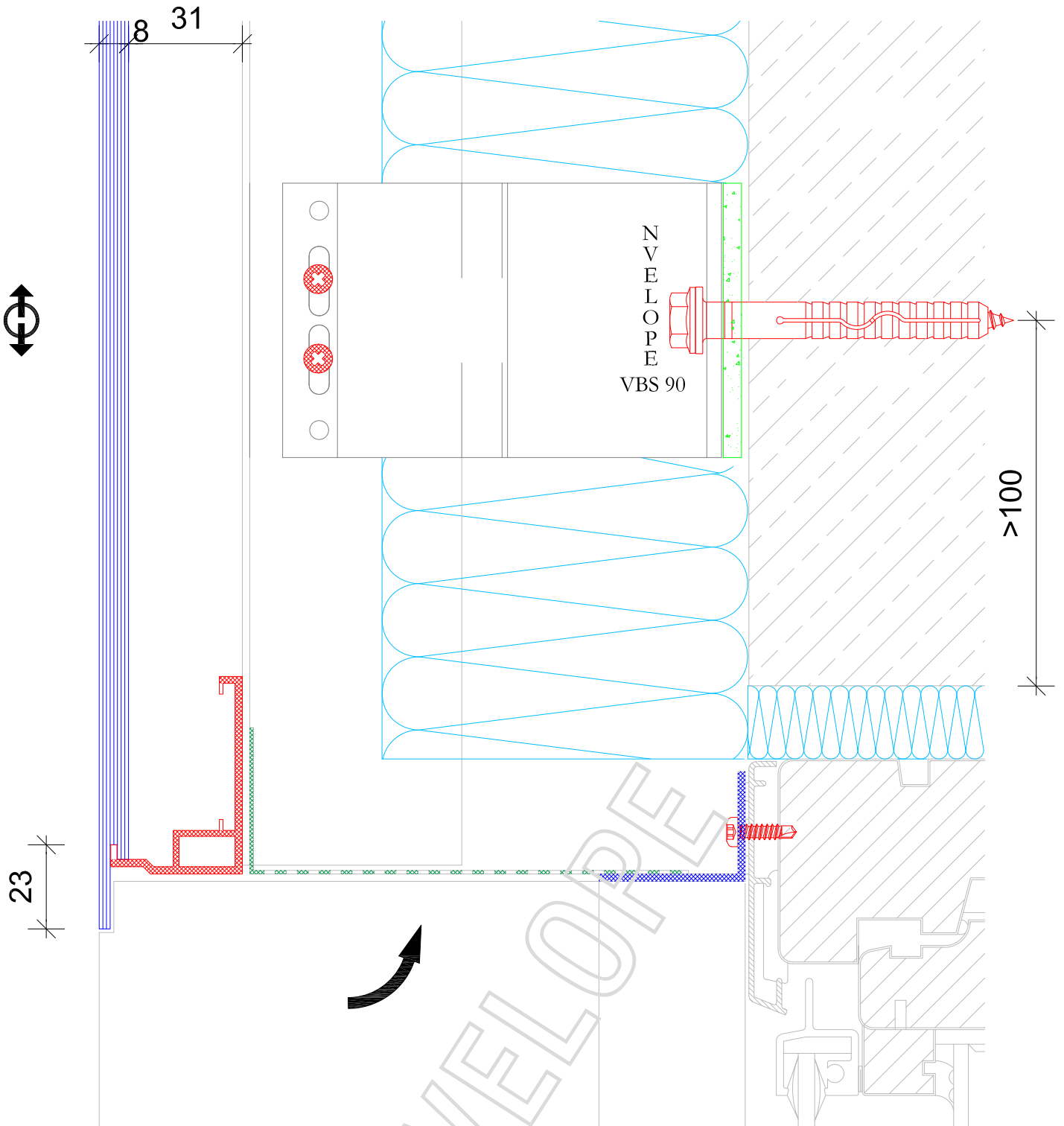

Vertical section - window head detail

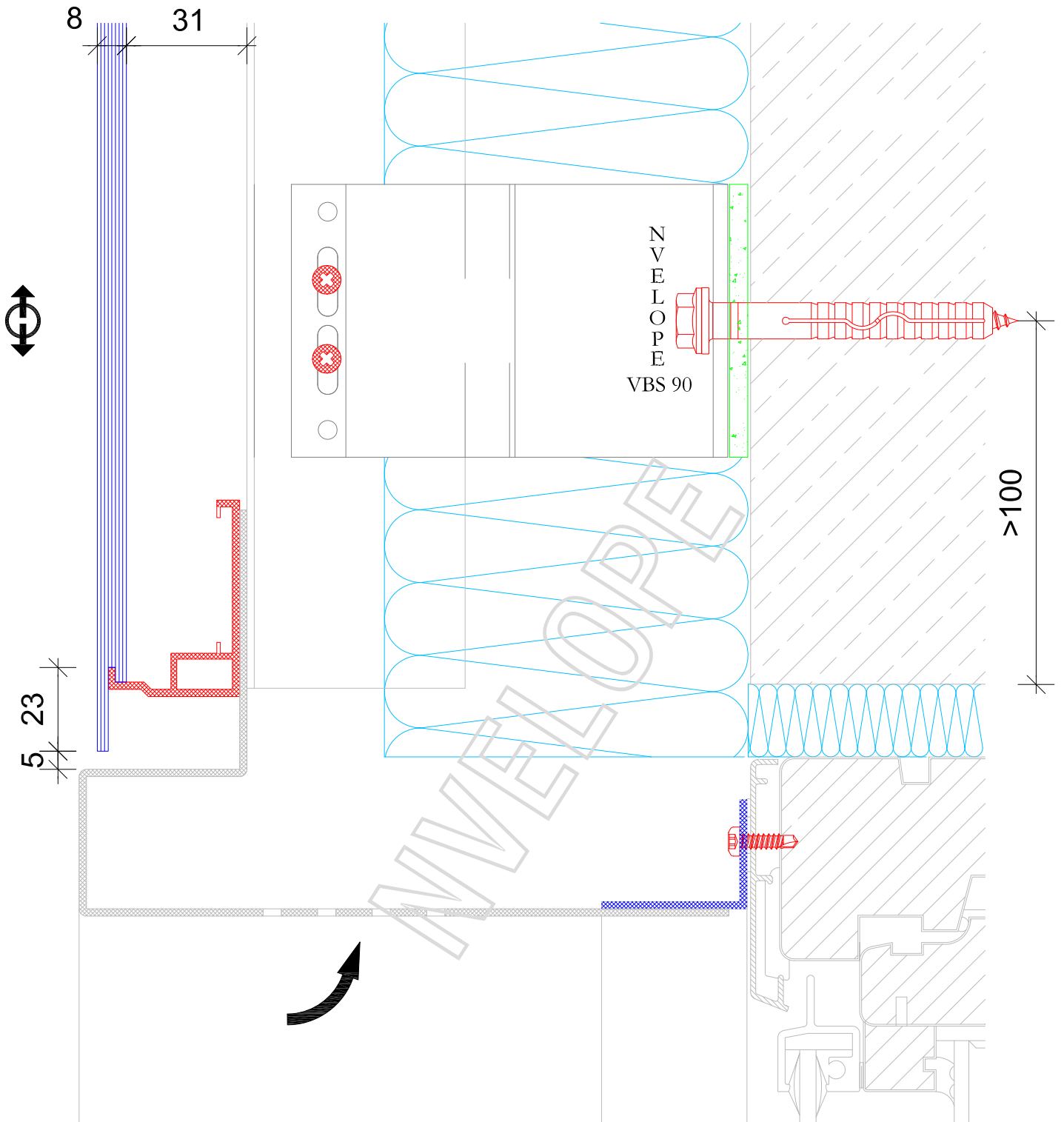

Vertical section - window head detail

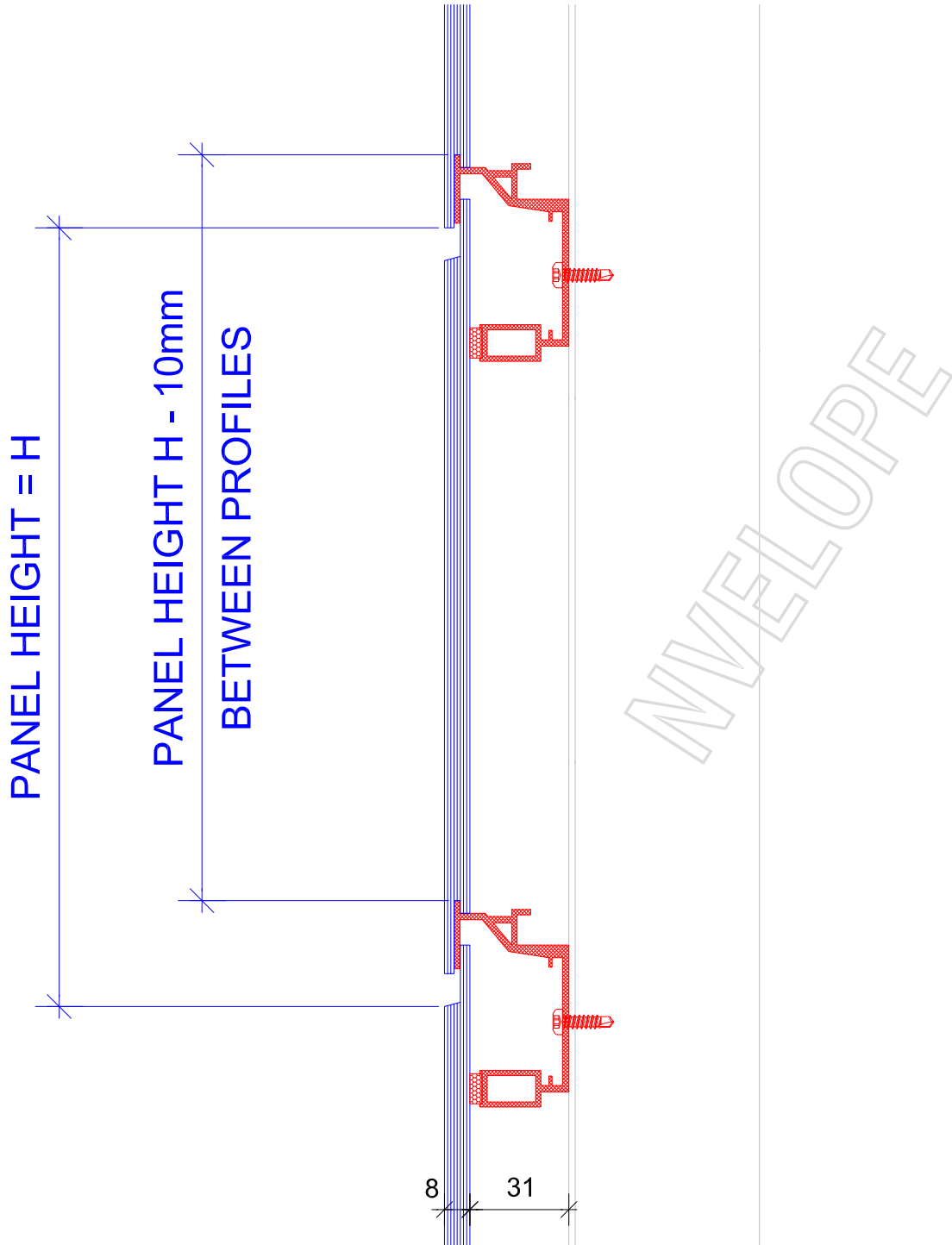

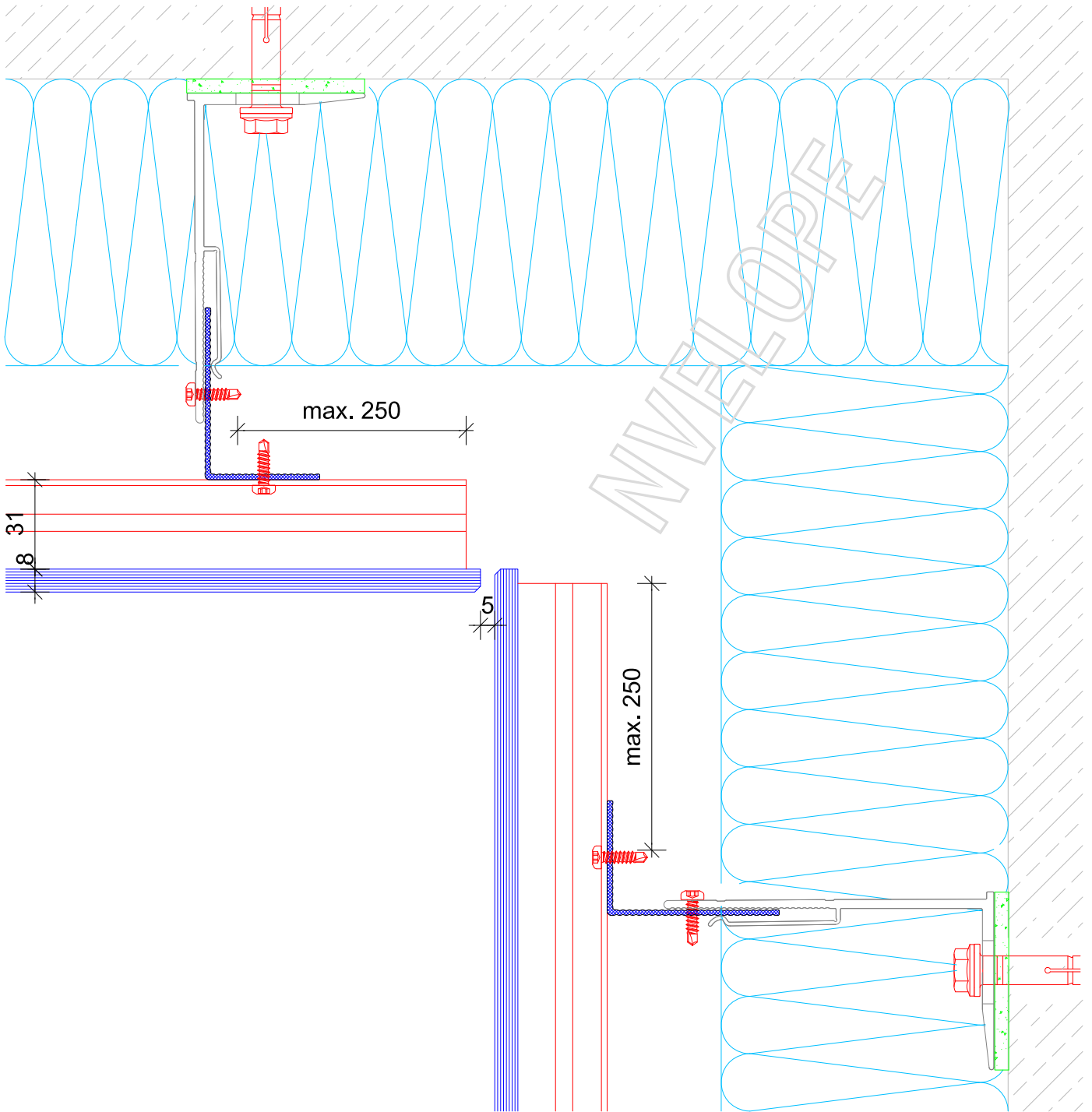

Horizontal section - internal corner

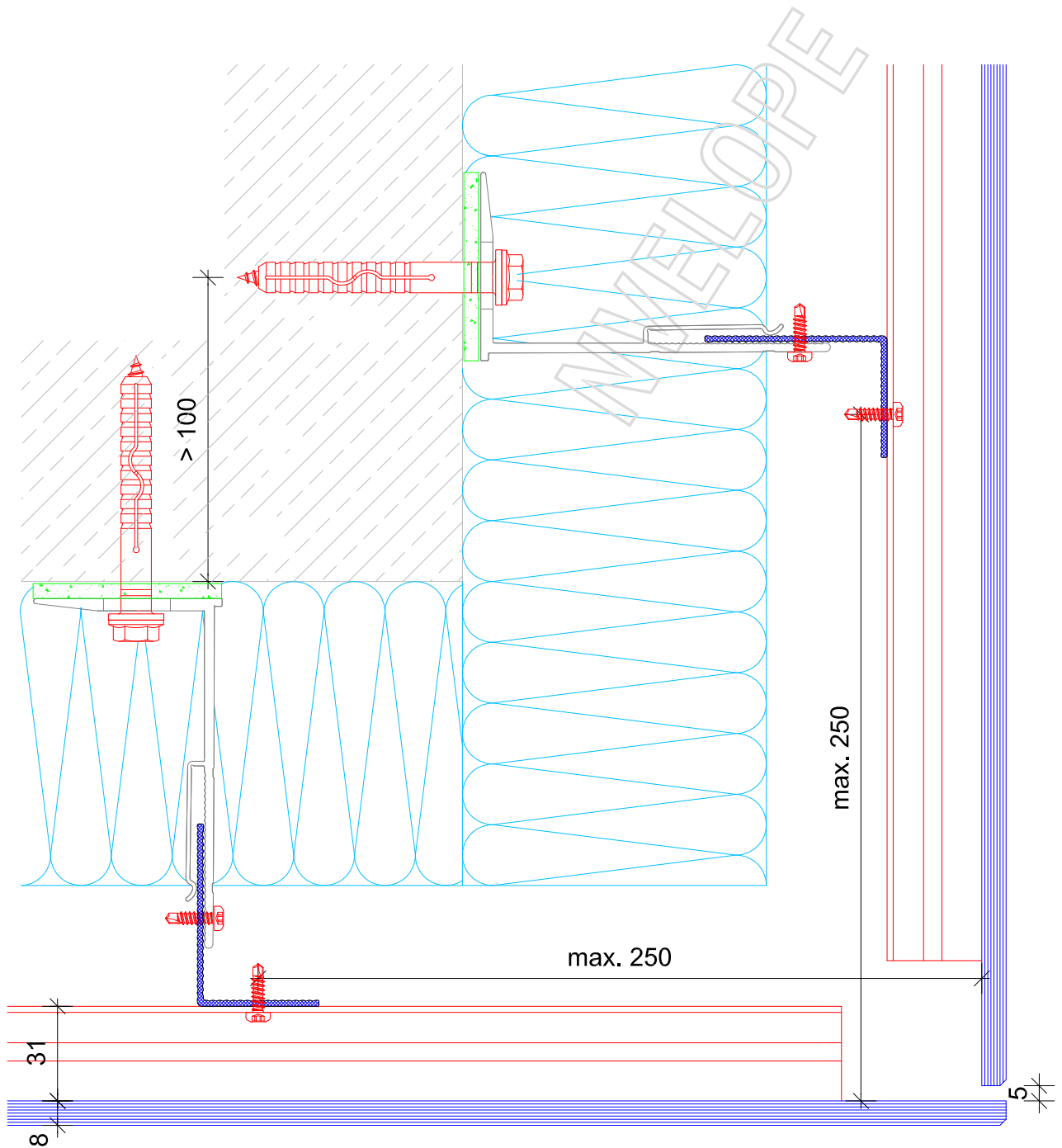

Horizontal section - external corner

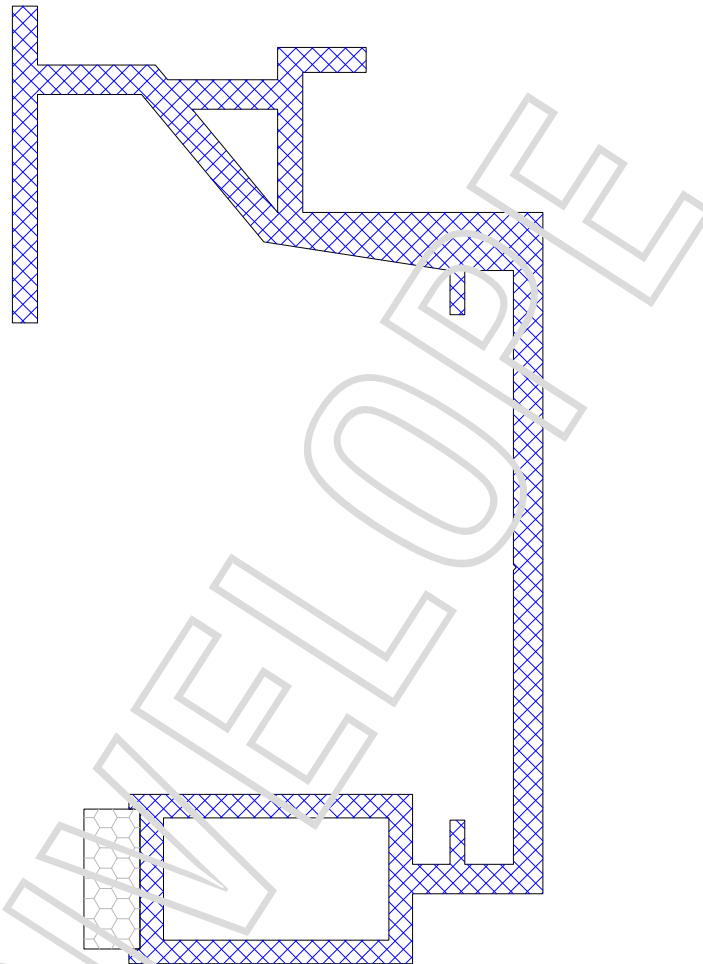

Remove backing
paper and Fit
Foam Tape in
Position shown.

TS 300 Main Support Rail
ref 05/TS300/MR